



Galaxy VM

The trusted partner for your business continuity
160-225 kVA (480 V)



se.com/ups

Life Is On

Schneider
Electric

High performance, low total cost of ownership

Galaxy VM is a highly efficient, easy-to-deploy, 160-225 kVA (480 V) 3-phase uninterruptible power supply (UPS) that seamlessly integrates into the electrical, physical, and monitoring environments of customers' medium data centers, industrial, or facilities applications.

Galaxy VM lowers your energy costs with up to 99% efficiency in eConversion mode and up to 96.5% efficiency in double conversion mode, and it seamlessly integrates into your electrical network with exceptional electrical performance.

Galaxy VM also delivers flexible battery solutions, including modular and classic VRLA batteries as well as compatibility with Lithium-ion and NiCad batteries.

Galaxy VM is EcoStruxure™ enabled, giving you visibility into the health of your UPS and peace of mind by sending real-time status updates directly to your smartphone. Designed for straightforward integration into any electrical network, Galaxy VM is the ideal choice to protect your critical infrastructure and your operating budget.



Key advantages and innovations



99% efficient in patented eConversion mode

Recover your initial investment within two-to-three years through energy savings.



Patented hybrid technology

Provides up to 96.5% efficiency in double conversion mode.



Battery flexibility, including Lithium-ion batteries*

Increase availability and reduce Total Cost of Ownership (TCO) with long-life, intelligent energy storage.



Maximum availability thanks to modular architecture

Critical system components built as modules for faster serviceability and fault tolerance. N+1 redundancy and scalability options available.



EcoStruxure IT

Monitor, manage, and model your IT infrastructure, and get service support, anytime, anywhere.*

Galaxy VM also complies with these standards:

- TAA-compliant UPS*



OSHPD

Well-suited for a wide range of data center and industrial applications

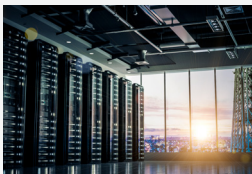

Data center and commercial buildings

- Medium and large data centers
- Computer rooms
- Retail/office space
- Manufacturing facilities



Transportation

- Lighting
- Air traffic control
- Security
- Signaling and communication systems



Healthcare

- Radiology and imaging equipment
- Operating rooms and Intensive Care Units
- Emergency power systems



Minerals, Metals & Mining

- Furnace process control
- Glass plants
- Emergency lighting



Oil & gas

- Refining
- Petrochemicals
- Gas processing control
- Well pumps



Power & Grid

- Thermal plants
- Generator protection
- Hydro turbine control
- Wind farm monitoring

*Contact your local representative for availability.

Seamless integration and start-up

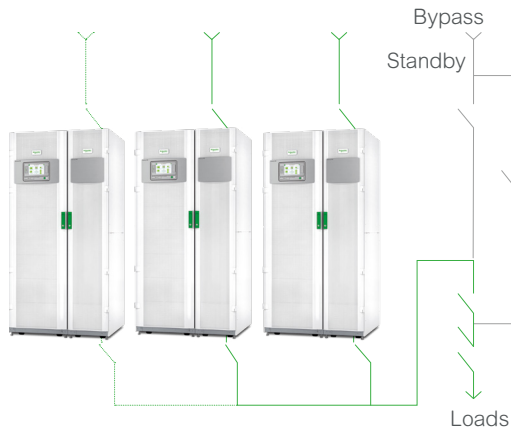

Paralleling capability of up to five UPS units for redundancy and up to four for capacity



Integration into your electrical network

- Wide input voltage and frequency ranges
- Genset compliant with adaptive ramp-in
- Integrated parallel capability: up to four UPS units
- Built-in integrated and tested back-feed protection

Integration with monitoring solutions

- Integrated network management capability for easy access to the network
- EcoStruxure connected; fully integrates into the comprehensive Schneider Electric™ energy management solution for data centers and industrial applications
- Straightforward integration with facility infrastructure monitoring systems, including BMS and Modbus (SCADA and ION-E)

Integration into your facility infrastructure

- Compact footprints
- Back-to-the-wall installation
- Operates at 40 °C without derating
- Embedded seismic design (OSHPD, IBC2012, and CBC2013 to Sds=2.02g)
- Low audible noise levels
- Replaceable dust filter for harsh environments
- Configurable input/output relays
- Customizable dry contacts
- 7-inch touch-screen color display
- Top and bottom cable entry
- Cold start: capability to start the UPS on battery without mains power present
- External synchronization capability
- Parallel UPS configurations can be connected to a common battery without the need for a battery coupling cabinet, reducing footprint and increasing cost savings

Smart power test

- Ability to test the UPS at full load without the need to rent a load bank and before bringing customers' load online

Straightforward installation

- System designed for ease of cabling in confined installation spaces
- Quick and easy installation: Fully isolated input/output cabinet that includes top or bottom cable entry provides great flexibility to the installer
- Ease of mobility: Integrated casters on UPS and modular battery cabinets allow cabinets to be moved easily and installed up against the wall

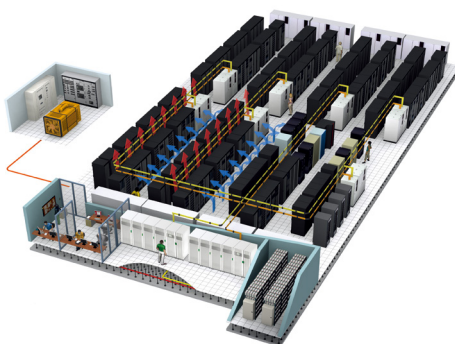

Premium protection and sustainability

eConversion: an unbeatable combination of power quality and high efficiency

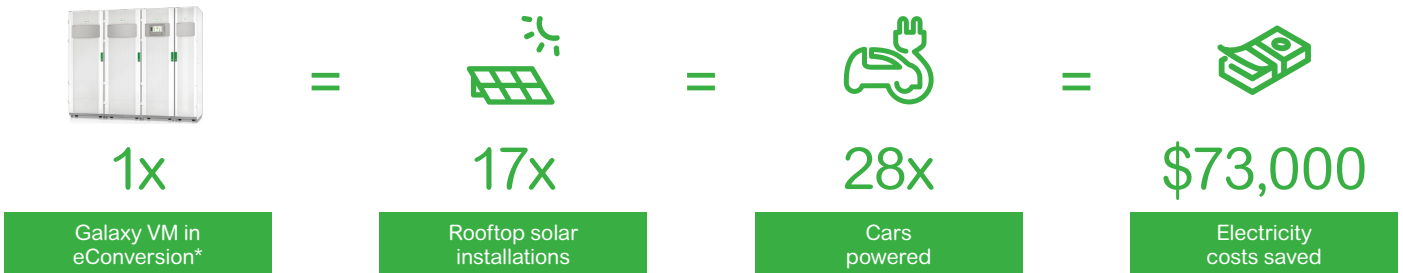

Sustainably reduce your operating costs

Protect power to your load, reduce your total cost of ownership and electricity consumption, and meet your sustainability goals with up to 99% efficient, Class 1-compliant eConversion mode for Galaxy V-series UPSs, the recommended operating mode for your Galaxy V-series UPS.*

- By operating at up to **99% efficiency**, the electricity savings in eConversion within 10 years typically equals **3x the price of the UPS**.
- The inverter operates continuously, protecting the load with **no transfer time**. eConversion performance has been certified with the same IEC 62040-3 **Class 1** rating as double conversion mode.
- eConversion mode recharges batteries and provides power factor correction and harmonics compensation, making it a **versatile solution for IT and non-IT loads**.
- Since its launch in 2014, eConversion has been successfully deployed all over the world. Join thousands of customers who use it daily to protect their critical loads.

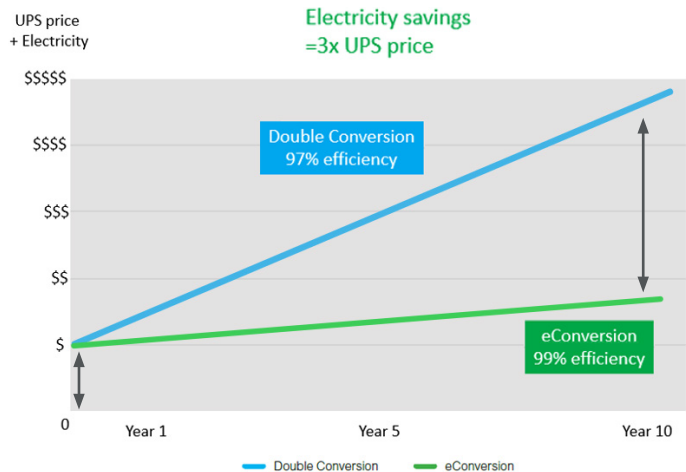

Calculate your savings

Use our eConversion vs. Double Conversion Calculator to quickly assess your potential energy savings, operating cost optimization, and CO₂ emissions reduction by comparing the cost of running your Galaxy V-Series UPS in eConversion mode vs. double conversion mode.



Scan the QR code with your phone camera, or [click here](#) to access the calculator from the Schneider Electric Data Center Trade Off Tools™ Web page.

[Learn more about eConversion](#)

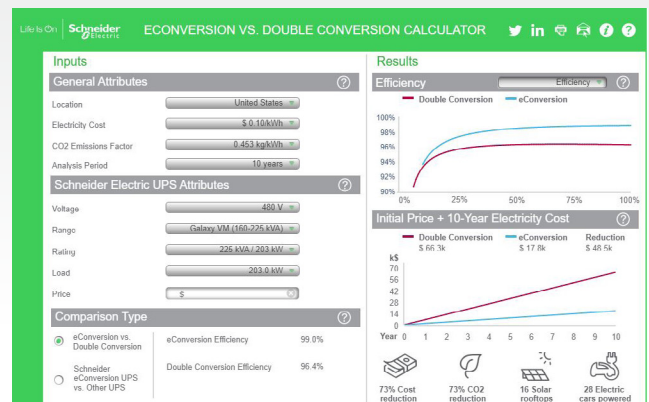

*Model dependent; based on a market electricity price: \$0.15 /kWh. The annual electricity savings are calculated by comparing the UPS efficiency in eConversion mode vs. double conversion mode.

Flexible, intelligent energy storage

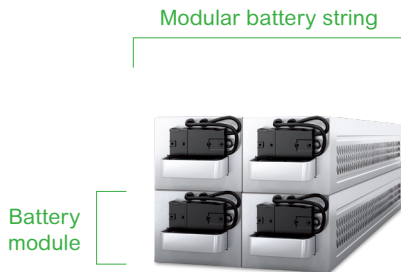

Improved availability, including long-life options

- **Increased availability:** Four battery modules form one modular battery string. All battery modules support the load, so no individual battery is a single point of failure
- **Reduced Mean Time To Repair (MTTR):** Replace a battery module in just a few minutes

Accurate anytime replacement

- **Simple:** Push-in and plug; unplug and pull-out
- **Safety first:** Touchproof connectors
- **Self-configuring:** The UPS automatically detects the presence and type of batteries, so the battery configuration is updated accurately

Battery monitoring included

- **Sensors:** Each battery module contains two temperature sensors and a battery identification device for self-configuration
- **Runtime:** The estimate on the display interface updates when battery modules are removed or installed
- **Quick status on display:** Use the UPS display to quickly identify and replace an inoperative battery module

Flexible, high-density energy storage

- **Right-sizing:** Easily increase runtime by adding battery modules or installing battery cabinets
- **High density:** Integrate batteries in the UPS to reduce footprint. No need for service clearance between battery rows

Long-life Galaxy Lithium-ion batteries

As a first mover with a vast installed base, Schneider Electric has developed its own Galaxy Lithium-ion battery solution that also delivers these benefits:

- **Double** your battery life compared with any VRLA battery, optimizing TCO and achieving sustainability targets
- Recharge **2–3x faster** than VRLA solutions
- High temperature tolerance
- Simplify and speed up installation with our internal power supply
- Enhance battery safety with three levels of battery management system (BMS)

[Click here](#)

for Lithium-ion / VRLA battery comparison



Lithium-ion compared to VRLA batteries

- **60–70%** less weight
- **2–3X** expected life
- **Higher** operating temp. (less cooling)
- **2–3X** faster recharge

Increase reliability and streamline deployment

Speed up deployment time, reduce start-up costs, and increase onsite reliability of the UPS operation by using the Smart Power Test (SPoT) mode before connecting your critical load.

SPoT (Smart Power Test)

SPoT enables the field service engineer (FSE) to test the UPS with full capacity current flow through important components and converters, without using a large system input current and without needing a load bank connected to the system or other system modifications.

- Simple, easy, and safe method to test the UPS at full power
- Can be conducted after service, repair, upgrade, or commissioning of UPS installation to verify system is properly installed
- Reduce risk to load and improve product quality
- Significant cost, time, and power savings

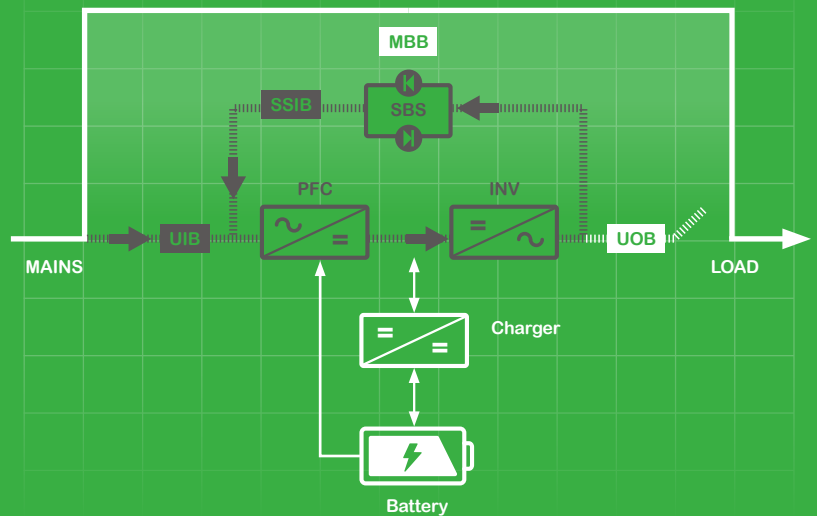

Visibility and peace of mind

EcoStruxure IT enables resilient, secure, and sustainable data centers and IT environments

Schneider Electric's comprehensive Data Center Infrastructure Management (DCIM) solution, EcoStruxure IT, ensures business continuity by enabling secure monitoring, management, insights, planning, and modeling – whether from a single IT rack to hyper-scale IT – on-premises, in the cloud, and at the edge.



Resilient



Secure



Sustainable

Easy visibility

Monitoring and management software streamlines data center device management:

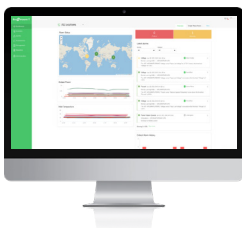

EcoStruxure IT Expert provides you a hands-on approach with **cloud-based** monitoring software that synthesizes and analyzes performance and alert data into proactive recommendations and enables wherever-you-go visibility from any device. Try it now: www.ecostruxureit.com/ecostruxure-it-expert/#trial

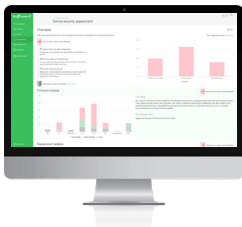

EcoStruxure Data Center Expert is a scalable end-to-end **on-premise** monitoring software that collects, organizes, and distributes critical device information, providing a comprehensive view of your company-wide, multi-vendor physical infrastructure.

24/7 peace of mind

Digital services proactively monitor your critical devices:

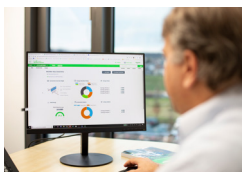

EcoStruxure Asset Advisor* for secure power and cooling provides you a hands-off approach with 24/7 remote monitoring service by the Schneider Electric Connected Services Hub experts.

We monitor and troubleshoot, you relax.

Operations, optimized

Planning and modeling software transforms data into performance insights:

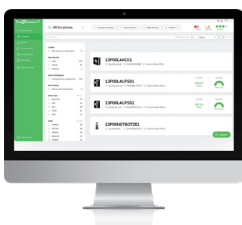

EcoStruxure IT Advisor is a data center infrastructure planning and modeling solution that provides Data Center Managers in large enterprises and colocation data centers with full insights into their infrastructure to improve profitability, sustainability, and resiliency.

* Contact your local representative for availability.

Comprehensive on-site services

Start-up service: included with UPS

- Commission the installation in accordance with manufacturer's recommendations. Ensure optimal system performance from Day 1

Schneider Electric-certified installation services

- Expert configuration of your equipment for optimal performance and reliability

Maintenance services

- Ensure proper care of your mission-critical applications
- Preventive maintenance and response time upgrades, where available

Flexible service plans/ on-site extended warranty

- Hassle-free system maintenance
- Improve uptime at a predictable cost

Options and accessories

Batteries



Battery cabinets



Wall-mounted battery breaker box



Classic battery cabinets

Maintenance bypasses



Parallel system bypass cabinets

Accessories



Modular battery cartridge

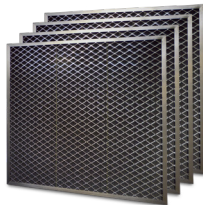

Dust filter kit



Dry contact I/O accessory (AP9810)

Galaxy VM management card compatibility chart

Network management	Description	Protocol supported
Included with Galaxy VM	<ul style="list-style-type: none"> • 1 plug: Ethernet SNMP • 1 plug: RS485 modbus RTU • 6 configurable dry contacts IN • 10 configurable dry contacts OUT • 2 free slots for optional communication cards 	<ul style="list-style-type: none"> • HTTP, HTTPS, IPv4, IPv6, NTP, SMTP, SNMP v1, SNMP v3, SSH V1, SSH V2, SSL, TCP/IP, Telnet, and modbus RTU

Technical specifications

Rated power (kVA/kW)	160/144	200/180	225/202.5
Normal AC supply input			
Input voltage (V)	360–576 (480 V 3-phase)		
Normal and bypass AC inputs	Single input standard, dual input optional		
Frequency (Hz)	40–70 Hz		
Input power factor	0.99 at greater than 40% load		
THDI	< 3% full load		
Bypass AC input			
Input voltage range	432–528 V		
Frequency	50 Hz or 60 Hz		
Output			
Phase-to-phase output voltage (V)	480 V (208 V & 600 V with transformer)		
Load power factor	0.9		
Output frequency	50/60 Hz +/- 0.1% (free-running)		
Overload capacity utility operation at 40 °C	150% for 1 minute and 125% for 10 minute		
Output voltage regulation	+/- 1%		
Total harmonic distortion (THDU)	< 2% at 100% linear load; < 3% at 100% non-linear load		
Output voltage tolerance	Symmetric load (0 – 100%): +/- 1% static; asymmetric load: +/- 3% static		
Overall efficiency			
Efficiency at full load (AC-AC) at 100% load	Up to 96.5%		
eConversion mode	Up to 99%		
Standard ECO mode	Up to 99%		
Communication and management			
Control panel	Multifunction 7" touch-screen color LCD display with built-in NMC, Modbus (SCADA and ION-E), two empty NMC card slots		
Dimensions and weights			
UPS (H x W x D) mm	77.56 x 39.45 x 33.62 in.		
Weight in kg. (UPS) (total -power cabinet plus I/O cabinet)	1,494	1,494	1,549
450 kVA system bypass cabinet (H x W x D), weight	77.56 x 59.25 x 32.95 in. 1,069 lb		
675 kVA system bypass cabinet (H x W x D), weight	77.56 x 59.25 x 32.95 in. 1,113 lb.		
Regulatory			
Safety	UL 1778 Fourth Edition		
EMC/EMI/RFI	FCC 47 Part 15		
Markings	UL 1778		
Transportation	ISTA® 2B		
Seismic zone	OSHPD, IBC2012 and CBC2013 to Sds=2.02g		
Environmental			
Operating temperature	0 to 40 °C (32 to 104 °F)		
Storage temperature	-25 to 55 °C (-77 to 131 °F) without batteries -15 to 40 °C (5 to 104 °F) with batteries		
Relative humidity	0–95% noncondensing 3,280 ft. at 100% load		
Operating elevation	3,280 ft at 100% load		
Storage elevation	0–49,212 ft		
Max. audible noise at 1 m from unit	55 dB at 70% load, 65 dB at 100% load		

Life Is On



To learn more about the Galaxy VM UPS and EcoStruxure IT DCIM, contact your Schneider Electric representative or visit se.com/ups

About Schneider Electric At Schneider Electric, we believe access to energy and digital is a basic human right. We empower all to **make the most of their energy and resources**, ensuring **Life Is On** everywhere, for everyone, at every moment. We provide **energy and automation digital** solutions for **efficiency and sustainability**. We combine world-leading energy technologies, real-time automation, software and services into integrated solutions for Homes, Buildings, Data Centers, Infrastructure and Industries. We are committed to unleash the infinite possibilities of an **open, global, innovative community** that is passionate about our **Meaningful Purpose, Inclusive and Empowered** values.

www.se.com

Schneider Electric SE
35 rue Joseph Monier
92500 Rueil Malmaison – France
se.com